

CloudEngine S5731-H Series Hybrid Optical-Electrical Switches Datasheet

CloudEngine S5731-H series hybrid optical-electrical switches are next-generation intelligent switches that provide GE/10GE hybrid optical-electrical downlink ports and four 10GE uplink ports, and provide one extended slot.

Introduction

The CloudEngine S5731-H series switches are the next-generation intelligent hybrid optical-electrical fixed switches developed by Huawei. The CloudEngine S5731-H builds on Huawei's unified Versatile Routing Platform (VRP) and boasts various IDN features. For example, the integrated wireless AC capabilities can manage up to 1,024 wireless APs; the free mobility feature ensures consistent user experience; the VXLAN functionality implements network virtualization; supports innovative optical-electrical synergy technologies and integrates optical ports and electrical ports.;function as a central switch to provide 60 W PoE++ power for remote units (RUs) at 300 m;and built-in security probes support abnormal traffic detection, threat analysis even in encrypted traffic, and network-wide threat deception. With these merits, the CloudEngine S5731-H can function as core switches for small-sized campus networks and branches of medium- and large-sized campus networks, and also work as access switches for Metropolitan Area Network.

Product Overview

Models and Appearances

The following models are available in the CloudEngine S5731-H series.

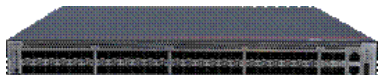



Models and Appearances	Description
 CloudEngine S5731-H24HB4XZ	<ul style="list-style-type: none"> • 20 x GE SFP ports+ 4 x 10GE SFP+ ports, 4 x 10GE SFP+ ports • One extended slot • 1+1 power backup • POE++ • Switching capacity: 360Gbps/672Gbps
 CloudEngine S5731-H48HB4XZ	<ul style="list-style-type: none"> • 44 x GE SFP ports+ 4 x 10GE SFP+ ports, 4 x 10GE SFP+ ports • One extended slot • 1+1 power backup • PoE++ • Switching capacity: 408Gbps/672Gbps

Note: The value before the slash (/) refers to the device's switching capability, while the value after the slash (/) means the system's switching capability.

Subcards

The following table lists the subcards applicable to the CloudEngine S5731-H.

Technical specifications of the subcards applicable to the CloudEngine S5731-H series



Subcards	Technical Specifications	Applied Switch Model
 <p>S7Q02001</p>	<ul style="list-style-type: none"> • 2*40GE QSFP+ • Operating temperature: 0°C to 45°C (32°F to 113°F) • Relative humidity: 5% to 95% • Storage temperature: -40°C to +70°C (-40°F to +158°F) 	<ul style="list-style-type: none"> • CloudEngine S5731-H24T4XC • CloudEngine S5731-H24P4XC • CloudEngine S5731-H48T4XC • CloudEngine S5731-H48P4XC <p>Note: Only V200R021C01 and later versions</p>
 <p>ES5D21Q02Q00</p>	<ul style="list-style-type: none"> • 2*40GE QSFP+ • Operating temperature: 0°C to 45°C (32°F to 113°F) • Relative humidity: 5% to 95% • Storage temperature: -40°C to +70°C (-40°F to +158°F) 	<ul style="list-style-type: none"> • CloudEngine S5731-H24T4XC • CloudEngine S5731-H24P4XC • CloudEngine S5731-H48T4XC • CloudEngine S5731-H48P4XC
 <p>ES5D21X08T00</p>	<ul style="list-style-type: none"> • 8*10GE Base-T • Operating temperature: 0°C to 45°C (32°F to 113°F) • Relative humidity: 5% to 95% • Storage temperature: -40°C to +70°C (-40°F to +158°F) 	<ul style="list-style-type: none"> • CloudEngine S5731-H24T4XC • CloudEngine S5731-H24P4XC • CloudEngine S5731-H48T4XC • CloudEngine S5731-H48P4XC
 <p>S7X08000</p>	<ul style="list-style-type: none"> • 8*10GE SFP+ or 2*25GE SFP28 • Operating temperature: 0°C to 45°C (32°F to 113°F) • Relative humidity: 5% to 95% • Storage temperature: -40°C to +70°C (-40°F to +158°F) <p>Note: The 8*10GE SFP+ subcard works as 8*10GE SFP+ by default, and can be changed to 2*25GE SFP28 as required.</p>	<ul style="list-style-type: none"> • CloudEngine S5731-H24T4XC • CloudEngine S5731-H24P4XC • CloudEngine S5731-H48T4XC • CloudEngine S5731-H48P4XC <p>Note: Only V200R019C10 and later versions</p>

Power Supply

The following table lists the power supplies applicable to the CloudEngine S5731-H.

Technical specifications of the power supplies applicable to the CloudEngine S5731-H series

Power Module	Technical Specifications	Applied Switch Model
 <p>PAC600S56-CB</p>	<ul style="list-style-type: none"> • Dimensions (H x W x D): 40 mm x 90 mm x 215 mm (1.6 in. x 3.5 in. x 8.5 in.) • Weight: 1.1 kg (2.43 lb) • Rated input voltage range: <ul style="list-style-type: none"> – 100 V AC to 130 V AC; 50/60 Hz – 100 V AC to 240 V AC, 50/60 Hz – 240 V DC • Maximum input voltage range: <ul style="list-style-type: none"> – 90 V AC to 290 V AC, 45 Hz to 66 Hz – 190 V DC to 290 V DC • Maximum input current: <ul style="list-style-type: none"> – 100 V AC to 130 V AC: 8 A 	<ul style="list-style-type: none"> • CloudEngine S5731-H24HB4XZ • CloudEngine S5731-H48HB4XZ

Power Module	Technical Specifications	Applied Switch Model
	<ul style="list-style-type: none"> - 100 V AC to 240 V AC: 8 A - 240 V DC: 4 A • Rated output current: <ul style="list-style-type: none"> - 100 V AC to 130 V AC input: 5.36 A - 200–240 V AC and 240 V DC input: 10.72 A • Rated output voltage: 56 V • Rated output power: <ul style="list-style-type: none"> - 100 V AC to 130 V AC input: <ul style="list-style-type: none"> · Total power: 300 W - 200 V AC to 240 V AC input and 240 V DC input: <ul style="list-style-type: none"> · Total power: 600 W • Hot swap: Supported 	
 <p>PAC1000S56-DB</p>	<ul style="list-style-type: none"> • Dimensions (H x W x D): 40 mm x 90 mm x 215 mm (1.6 in. x 3.5 in. x 8.5 in.) • Weight: 1.1 kg (2.43 lb) • Rated input voltage range: <ul style="list-style-type: none"> - 100 V AC to 130 V AC, 50/60 Hz - 200 V AC to 240 V AC, 50/60 Hz - 240 V DC • Maximum input voltage range: <ul style="list-style-type: none"> - 90 V AC to 290 V AC, 45 Hz to 65 Hz - 190 V DC to 290 V DC • Input current: <ul style="list-style-type: none"> - 100 V AC to 130 V AC: 12 A - 200 V AC to 240 V AC: 8 A - 240 V DC: 8 A • Maximum output current: <ul style="list-style-type: none"> - 100 V AC to 130 V AC input: 16.08 A - 200 V AC to 240 V AC input and 240 V DC input: 17.86 A • Maximum output power: <ul style="list-style-type: none"> - Total power: 900 W (100 V AC to 130 V AC input)/1000 W (200 V AC to 240 V AC input and 240 V DC input) • Hot swap: Supported 	<ul style="list-style-type: none"> • CloudEngine S5731-H24HB4XZ • CloudEngine S5731-H48HB4XZ
 <p>PDC1000S56-CB</p>	<ul style="list-style-type: none"> • Dimensions (H x W x D): 40 mm x 90 mm x 215 mm (1.6 in. x 3.5 in. x 8.5 in.) • Weight: 1.02 kg (2.25 lb) • Rated input voltage range: -48 V DC to -60 V DC • Maximum input voltage range: -38.4 V DC to -72 V DC • Maximum input current: 30 A • Maximum output current: 83.3 A • Maximum output power: 1000 W • Hot swap: Supported 	<ul style="list-style-type: none"> • CloudEngine S5731-H24HB4XZ • CloudEngine S5731-H48HB4XZ

Power Module	Technical Specifications	Applied Switch Model
 <p>PAC1000S56-CB</p>	<ul style="list-style-type: none"> • Dimensions (H x W x D): 40 mm x 90 mm x 215 mm (1.6 in. x 3.5 in. x 8.5 in.) • Weight: 1.1 kg (2.43 lb) • Rated input voltage range: <ul style="list-style-type: none"> – 100 V AC to 130 V AC, 50/60 Hz – 200 V AC to 240 V AC, 50/60 Hz – 240 V DC • Maximum input voltage range: <ul style="list-style-type: none"> – 90 V AC to 290 V AC, 45 Hz to 65 Hz – 190 V DC to 290 V DC • Input current: <ul style="list-style-type: none"> – 100 V AC to 130 V AC: 12 A – 200 V AC to 240 V AC: 8 A – 240 V DC: 8 A • Maximum output current: <ul style="list-style-type: none"> – 100 V AC to 130 V AC input: 16.08 A – 200 V AC to 240 V AC input and 240 V DC input: 17.86 A • Maximum output power: <ul style="list-style-type: none"> – Total power: 900 W (100 V AC to 130 V AC input)/1000 W (200 V AC to 240 V AC input and 240 V DC input) • Hot swap: Supported 	<ul style="list-style-type: none"> • CloudEngine S5731-H24HB4XZ • CloudEngine S5731-H48HB4XZ

CloudEngine S5731-H series switches support PoE. They have two power module slots, each of which can have a 1000 W PoE power module installed.

The following table lists its power supply configurations.

Power supply configurations of CloudEngine S5731-H

Model	Power Module 1	Power Module 2	Available PoE Power	Maximum Number of Ports (Fully Loaded)
CloudEngine S5731-H24HB4XZ	1000 W AC (220 V) 1000 W DC	–	818 W	<ul style="list-style-type: none"> • 802.3af (15.4 W per port): 24 • 802.3at (30 W per port): 24 • 802.3bt (60 W per port): 13 • 802.3bt (90 W per port): 9
	1000 W AC (110 V)	–	723 W	<ul style="list-style-type: none"> • 802.3af (15.4 W per port): 24 • 802.3at (30 W per port): 24 • 802.3bt (60 W per port): 12 • 802.3bt (90 W per port): 8
	1000 W AC (220 V) 1000 W DC	1000 W AC (220 V) 1000 W DC	1768 W	<ul style="list-style-type: none"> • 802.3af (15.4 W per port): 24 • 802.3at (30 W per port): 24 • 802.3bt (60 W per port): 24 • 802.3bt (90 W per port): 19
	1000 W AC (110 V) 1000 W DC	1000 W AC (110 V)	1578 W	<ul style="list-style-type: none"> • 802.3af (15.4 W per port): 24 • 802.3at (30 W per port): 24

Model	Power Module 1	Power Module 2	Available PoE Power	Maximum Number of Ports (Fully Loaded)
				<ul style="list-style-type: none"> 802.3bt (60 W per port): 24 802.3bt (90 W per port): 17
	600 W AC (220 V)	–	438 W	<ul style="list-style-type: none"> 802.3af (15.4 W per port): 24 802.3at (30 W per port): 14 802.3bt (60 W per port): 7 802.3bt (90 W per port): 4
	600 W AC (110 V)	–	153 W	<ul style="list-style-type: none"> 802.3af (15.4 W per port): 9 802.3at (30 W per port): 5 802.3bt (60 W per port): 2 802.3bt (90 W per port): 1
	600 W AC (220 V)	600 W AC (220 V)	1008 W	<ul style="list-style-type: none"> 802.3af (15.4 W per port): 24 802.3at (30 W per port): 24 802.3bt (60 W per port): 16 802.3bt (90 W per port): 11
	600 W AC (110 V)	600 W AC (110 V)	438 W	<ul style="list-style-type: none"> 802.3af (15.4 W per port): 24 802.3at (30 W per port): 14 802.3bt (60 W per port): 7 802.3bt (90 W per port): 4
	1000 W AC (220 V) 1000 W DC	600 W AC (220 V)	1388 W	<ul style="list-style-type: none"> 802.3af (15.4 W per port): 24 802.3at (30 W per port): 24 802.3bt (60 W per port): 23 802.3bt (90 W per port): 15
CloudEngine S5731-H48HB4XZ	1000 W AC (220 V) 1000 W DC	–	795 W	<ul style="list-style-type: none"> 802.3af (15.4 W per port): 48 802.3at (30 W per port): 26 802.3bt (60 W per port): 13 802.3bt (90 W per port): 8
	1000 W AC (110 V)	–	700 W	<ul style="list-style-type: none"> 802.3af (15.4 W per port): 45 802.3at (30 W per port): 23 802.3bt (60 W per port): 11 802.3bt (90 W per port): 7
	1000 W AC (220 V) 1000 W DC	1000 W AC (220 V) 1000 W DC	1745 W	<ul style="list-style-type: none"> 802.3af (15.4 W per port): 48 802.3at (30 W per port): 48 802.3bt (60 W per port): 29 802.3bt (90 W per port): 19
	1000 W AC (110 V) 1000 W DC	1000 W AC (110 V)	1555 W	<ul style="list-style-type: none"> 802.3af (15.4 W per port): 48 802.3at (30 W per port): 48 802.3bt (60 W per port): 25 802.3bt (90 W per port): 17
	600 W AC (220 V)	–	415 W	<ul style="list-style-type: none"> 802.3af (15.4 W per port): 26 802.3at (30 W per port): 13 802.3bt (60 W per port): 6

Model	Power Module 1	Power Module 2	Available PoE Power	Maximum Number of Ports (Fully Loaded)
				<ul style="list-style-type: none"> 802.3bt (90 W per port): 4
	600 W AC (110 V)	–	130 W	<ul style="list-style-type: none"> 802.3af (15.4 W per port): 8 802.3at (30 W per port): 4 802.3bt (60 W per port): 2 802.3bt (90 W per port): 1
	600 W AC (220 V)	600 W AC (220 V)	985 W	<ul style="list-style-type: none"> 802.3af (15.4 W per port): 48 802.3at (30 W per port): 32 802.3bt (60 W per port): 16 802.3bt (90 W per port): 10
	600 W AC (110 V)	600 W AC (110 V)	415 W	<ul style="list-style-type: none"> 802.3af (15.4 W per port): 26 802.3at (30 W per port): 13 802.3bt (60 W per port): 6 802.3bt (90 W per port): 4
	1000 W AC (220 V) 1000 W DC	600 W AC (220 V)	1365 W	<ul style="list-style-type: none"> 802.3af (15.4 W per port): 48 802.3at (30 W per port): 45 802.3bt (60 W per port): 22 802.3bt (90 W per port): 15

Product Features and Highlights

Simplified Architecture

Based on Huawei's unique simplified architecture, the traditional three-layer architecture of access, aggregation, and core is simplified into a two-layer architecture of access and core, greatly reducing network deployment and management complexity.

- Based on the simplified architecture, the access switches splits into the central switches and the remote units. The remote units function as the port expansion module of the central switch to flexibly expand the port capacity of the central switch. One device is a network.
- The remote units are connected to the central switch through optical cables or optical/electrical hybrid cables, which does not require planning, configuration, management, and plug-and-play. When a device is expanded or faulty, replace the device with a new one, simplifying network planning, deployment, and routine O&M.

Note: The CloudEngine S12700E/S12700/S7700/S6700/S5700 series switches can be upgraded to V200R21C10 or a later version and can work with remote modules to implement simplified networking.

Enabling Networks to Be More Agile for Services

- The CloudEngine S5731-H has a built-in high-speed and flexible processor chip. The chip's flexible packet processing and traffic control capabilities can meet current and future service requirements, helping build a highly scalable network.
- In addition to capabilities of traditional switches, the CloudEngine S5731-H provides open interfaces and supports user-defined forwarding behavior. Enterprises can use the open interfaces to develop new protocols and functions independently or jointly with equipment vendors to build campus networks meeting their own needs.
- The CloudEngine S5731-H series switches, on which enterprises can define their own forwarding models, forwarding behavior, and lookup algorithms. Microcode programmability makes it possible to provide new services within six months, without the need of replacing the hardware. In contrast, traditional ASIC chips use a fixed forwarding architecture and follow a fixed forwarding process. For this reason, new services cannot be provisioned until new hardware is developed to support the services one to three years later.

Delivering Abundant Services More Agilely

- The CloudEngine S5731-H provides the integrated WLAN AC(native AC) function that can manage 1,024 APs, reducing the costs of purchasing additional WLAN AC hardware and breaking the forwarding performance bottleneck of an external WLAN AC. With this switch series, customers can stay ahead in the high-speed wireless era.
- With the unified user management function, the CloudEngine S5731-H authenticates both wired and wireless users, ensuring a consistent user experience no matter whether they are connected to the network through wired or wireless access devices. The unified user management function supports various authentication methods, including 802.1x, MAC address, and Portal authentication, and is capable of managing users based on user groups, domains, and time ranges. These functions visualize user and service management and boost the transformation from device-centric management to user experience-centric management.
- The CloudEngine S5731-H provides excellent quality of service (QoS) capabilities and supports queue scheduling and congestion control algorithms. Additionally, it adopts innovative priority queuing and multi-level scheduling mechanisms to implement fine-grained scheduling of data flows, meeting service quality requirements of different user terminals and services.

Note: The CloudEngine S5731-H can manage 16 APs by default . You can purchase licenses for more AP management on demand.

Providing Fine Granular Network Management More Agilely

- The CloudEngine S5731-H uses the Packet Conservation Algorithm for Internet (iPCA) technology that changes the traditional method of using simulated traffic for fault location. iPCA technology can monitor network quality for any service flow anywhere and anytime, without extra costs. It can detect temporary service interruptions in a very short time and can identify faulty ports accurately. This cutting-edge fault detection technology turns "extensive management" to "fine granular management."
- The CloudEngine S5731-H supports Two-Way Active Measurement Protocol (TWAMP) to accurately check any IP link and obtain the entire network's IP performance. This protocol eliminates the need of using a dedicated probe or a proprietary protocol.
- The CloudEngine S5731-H supports SVF and functions as a parent switch. With this virtualization technology, a physical network with the "small-sized core/aggregation switches + access switches + APs" structure can be virtualized into a "super switch", greatly simplifying network management.
- With the EasyDeploy function, the CloudEngine S5731-H manages access switches in a similar way a WLAN AC manages APs. In deployment, access switches and APs can go online with zero-touch configuration. In the EasyDeploy solution, the Commander collects topology information about the connected clients and stores the clients' startup information based on the topology. Clients can be replaced with zero-touch configuration. The Commander can deliver configurations and scripts to clients in batches and query the delivery results. In addition, the Commander can collect and display information about power consumption on the entire network.

Flexible Ethernet Networking

- In addition to traditional Spanning Tree Protocol (STP), Rapid Spanning Tree Protocol (RSTP), and Multiple Spanning Tree Protocol (MSTP), the CloudEngine S5731-H supports Huawei-developed Smart Ethernet Protection (SEP) technology and the latest Ethernet Ring Protection Switching (ERPS) standard. SEP is a ring protection protocol specific to the Ethernet link layer, and applies to various ring network topologies, such as open ring topology, closed ring topology, and cascading ring topology. This protocol is reliable, easy to maintain, and implements fast protection switching within 50 ms. ERPS is defined in ITU-T G.8032. It implements millisecond-level protection switching based on traditional Ethernet MAC and bridging functions.
- The CloudEngine S5731-H supports Smart Link and Virtual Router Redundancy Protocol (VRRP), which implement backup of uplinks. One CloudEngine S5731-H switch can connect to multiple aggregation switches through multiple links, significantly improving reliability of access devices.

Comprehensive VPN Technologies

- The CloudEngine S5731-H supports the MPLS function, and can be used as access devices of high-quality enterprise leased line.
- The CloudEngine S5731-H allows users in different VPNs to connect to the same switch and isolates users through multi-instance routing. Users in multiple VPNs connect to a provider edge (PE) device through the same physical port on the switch, which reduces the cost on VPN network deployment.

Various Security Control Methods

- The CloudEngine S5731-H supports Layer 2 and Layer 3 multicast protocols, PIM SM, PIM DM, PIM SSM, MLD, and IGMP snooping, meeting the requirements of multi-terminal HD video surveillance and video conference access.
- The CloudEngine S5731-H supports Layer 3 features such as OSPF, IS-IS, BGP, and VRRP, meeting enterprise access and aggregation service bearer requirements, and supporting more voice, video, and data applications.
- The CloudEngine S5731-H supports 802.1x authentication, MAC address authentication, Portal authentication, and hybrid authentication, and can dynamically deliver user policies such as VLANs, QoS policies, and access control lists (ACLs). It also supports user management based on user groups.
- The CloudEngine S5731-H provides a series of mechanisms to defend against DoS and user-targeted attacks. DoS attacks are targeted at switches and include SYN flood, Land, Smurf, and ICMP flood attacks. User-targeted attacks include bogus DHCP server attacks, IP/MAC address spoofing, DHCP request flood, and change of the DHCP CHADDR value.
- The CloudEngine S5731-H sets up and maintains a DHCP snooping binding table, and discards the packets that do not match the table entries. You can specify DHCP snooping trusted and untrusted ports to ensure that users connect only to the authorized DHCP server.
- The CloudEngine S5731-H supports strict ARP learning, which prevents ARP spoofing attackers from exhausting ARP entries.

Mature IPv6 Features

- The CloudEngine S5731-H is developed based on the mature, stable VRP and supports IPv4/IPv6 dual stacks, IPv6 routing protocols (RIPng, OSPFv3, BGP4+, and IS-IS for IPv6).
- With these IPv6 features, the CloudEngine S5731-H can be deployed on a pure IPv4 network, a pure IPv6 network, or a shared IPv4/IPv6 network, helping achieve IPv4-to-IPv6 transition.

Intelligent Stack (iStack)

- The CloudEngine S5731-H supports the iStack function that combines multiple switches into a logical switch.
- Member switches in a stack implement redundancy backup to improve device reliability and use inter-device link aggregation to improve link reliability.
- iStack provides powerful network expansion capabilities. By adding member devices, you can easily expand the number of ports, bandwidth, and processing capability of a stack system.
- iStack simplifies configuration and management. After a stack is formed, multiple physical devices are virtualized into one device. Users can log in to the stack through any member device to configure and manage all member devices in the stack in a unified manner.

VXLAN Features

- VXLAN is used to construct a Unified Virtual Fabric (UVF). As such, multiple service networks or tenant networks can be deployed on the same physical network, and service and tenant networks are isolated from each other. This capability truly achieves 'one network for multiple purposes'. The resulting benefits include enabling data transmission of different services or customers, reducing the network construction costs, and improving network resource utilization.
- The CloudEngine S5731-H series switches are VXLAN-capable and allow centralized and distributed VXLAN gateway deployment modes. These switches also support the BGP EVPN protocol for dynamically establishing VXLAN tunnels and can be configured using NETCONF/YANG.

Innovative PoE Power Supply

Based on innovative hybrid optical-electrical ports, the switches provide ultra-long-distance high-power power supply for remote modules: 220 m@90 W PoE++ power supply, 330 m@60 W PoE++ power supply, and 650 m@30 W PoE+ power supply. Meet the power supply distance and transmission distance requirements in specific scenarios. In addition, some RRUs support level-2 PoE to provide data access and power supply for terminals such as cameras, APs, and IP phones.

- Fast PoE: PoE switches can supply power to PDs within 10s after they are powered on. This is different from common switches that generally take 1 to 3 minutes to start to supply power to PDs. When a PoE switch reboots due to a power failure, the PoE switch continues to supply power to the PDs immediately after being powered on without waiting until it finishes reboot. This greatly shortens the power failure time of PDs.

- Perpetual PoE: When a PoE switch is warm rebooting (Don't turn PSE switch power off), for example, reboot upon the software upgrade, the power supply to PDs is not interrupted. This capability ensures that PDs are not powered off during the switch warm reboot.

NOTE

For more information about PoE, visit

<https://e.huawei.com/en/material/onLineView?materialid=e28cc3ad158140e8af1547bc510ecd34>

Intelligent O&M

- The CloudEngine S5731-H provides telemetry technology to collect device data in real time and send the data to Huawei campus network analyzer (iMaster NCE-CampusInsight). The CampusInsight analyzes network data based on the intelligent fault identification algorithm, accurately displays the real-time network status, effectively demarcates and locates faults in a timely manner, and identifies network problems that affect user experience, accurately guaranteeing user experience.
- The CloudEngine S5731-H supports a variety of intelligent O&M features for audio and video services, including the enhanced Media Delivery Index (eMDI). With this eMDI function, the switch can function as a monitored node to periodically conduct statistics and report audio and video service indicators to the CampusInsight platform. In this way, the CampusInsight platform can quickly demarcate audio and video service quality faults based on the results of multiple monitored nodes.

Intelligent Upgrade

- Switches support the intelligent upgrade feature. Specifically, switches obtain the version upgrade path and download the newest version for upgrade from the Huawei Online Upgrade Platform (HOUP). The entire upgrade process is highly automated and achieves one-click upgrade. In addition, preloading the version is supported, which greatly shortens the upgrade time and service interruption time.
- The intelligent upgrade feature greatly simplifies device upgrade operations and makes it possible for the customer to upgrade the version independently. This greatly reduces the customer's maintenance costs. In addition, the upgrade policies on the HOUP platform standardize the upgrade operations, which greatly reduces the risk of upgrade failures.

Big Data Security Collaboration

- The CloudEngine S5731-H switches use NetStream to collect campus network data and then report such data to the Huawei HiSec Insight. The purposes of doing so are to detect network security threats, display the security posture across the entire network, and enable automated or manual response to security threats. The HiSec Insight delivers the security policies to the iMaster NCE-Campus. The iMaster NCE-Campus then delivers such policies to switches that will handle security events accordingly. All these ensure campus network security.
- The CloudEngine S5731-H supports Encrypted Communication Analytics (ECA). It uses built-in ECA probes to extract characteristics of encrypted streams based on NetStream sampling and Service Awareness (SA), generates metadata, and reports the metadata to HiSec Insight. The HiSec Insight uses the AI algorithm to train the traffic model and compare characteristics of extracted encrypted traffic to identify malicious traffic. The HiSec Insight displays detection results on the GUI, provides threat handling suggestions, and automatically isolates threats with the iMaster NCE-Campus to ensure campus network security.
- The CloudEngine S5731-H supports deception. It functions as a sensor to detect threats such as IP address scanning and port scanning on a network and lures threat traffic to the honeypot for further checks. The honeypot performs in-depth interaction with the initiator of the threat traffic, records various application-layer attack methods of the initiator, and reports security logs to the HiSec Insight. The HiSec Insight analyzes security logs. If the HiSec Insight determines that the suspicious traffic is an attack, it generates an alarm and provides handling suggestions. After the administrator confirms the alarm, the HiSec Insight delivers a policy to the iMaster NCE-Campus. The iMaster NCE-Campus delivers the policy to the switch for security event processing, ensuring campus network security.

Cloud Management

- The Huawei cloud management platform allows users to configure, monitor, and inspect switches on the cloud, reducing on-site deployment and O&M manpower costs and decreasing network OPEX.
- Huawei switches support both cloud management and on-premise management modes. These two management modes can be flexibly switched as required to achieve smooth evolution while maximizing return on investment (ROI).

Open Programmability System (OPS)

- Open Programmability System (OPS) is an open programmable system based on the Python language. IT administrators can program the O&M functions of a switch through Python scripts to quickly innovate functions and implement intelligent O&M.

Licensing

CloudEngine S5731-H supports both the traditional feature-based licensing mode and the latest Huawei IDN One Software (N1 mode for short) licensing mode. The N1 mode is ideal for campus network deployments in enterprise private cloud mode, and greatly enhances the customer experiences in purchasing and upgrading software services with simplicity.

Software Package Features in N1 Mode

Switch Functions	N1 Basic Software	N1 Foundation Software Package	N1 Advanced Software Package
Basic network functions: Layer 2 functions, IPv4, IPv6, MPLS, SVF, and others Note: For details, see the Service Features	√	√	√
Basic network automation based on the iMaster NCE-Campus: <ul style="list-style-type: none"> Basic automation: Plug-and-play, SSID, and AP group management Basic monitoring: Application visualization NE management: Image and topology management and discovery WLAN enhancement: Roaming and optimization for up to 128 APs User access authentication 	x	√	√
Advanced network automation and intelligent O&M: VXLAN, free mobility, and CampusInsight basic functions	x	x	√

Note: Only V200R021C10 and later versions can support N1 mode

Product Specifications

Functions and Features

Except for special instructions, the following features are supported by CloudEngine S5731-H with N1 basic software.

Function and feature metrics for the CloudEngine S5731-H series

Function and Feature		Description	CloudEngine S5731-H
Ethernet features	Ethernet basics	Full-duplex, half-duplex, and auto-negotiation	Yes
		Rate auto-negotiation on an interface	Yes
		Auto MDI and MDI-X	Yes
		Flow control on an interface	Yes
		Jumbo frames	Yes
		Link aggregation	Yes
		Load balancing among links of a trunk	Yes
		Transparent transmission of Layer 2 protocol packets	Yes

Function and Feature		Description	CloudEngine S5731-H
		Device Link Detection Protocol (DLDP)	Yes
		Link Layer Discovery Protocol (LLDP)	Yes
		Link Layer Discovery Protocol-Media Endpoint Discovery (LLDP-MED)	Yes
		Interface isolation	Yes
		Broadcast traffic suppression on an interface	Yes
		Multicast traffic suppression on an interface	Yes
		Unknown unicast traffic suppression on an interface	Yes
		VLAN broadcast traffic suppression	Yes
		VLAN multicast traffic suppression	Yes
		VLAN unknown unicast traffic suppression	Yes
	VLAN	VLAN specification	4094
		VLANIF interface specification	1024
		Access mode	Yes
		Trunk mode	Yes
		Hybrid mode	Yes
		QinQ mode	Yes
		Default VLAN	Yes
		VLAN assignment based on interfaces	Yes
		VLAN assignment based on protocols	Yes
		VLAN assignment based on IP subnets	Yes
		VLAN assignment based on MAC addresses	Yes
		VLAN assignment based on MAC address + IP address	Yes
		VLAN assignment based on MAC address + IP address + interface number	Yes
		Adding double VLAN tags to packets based on interfaces	Yes
		Super-VLAN	Yes
		Super-VLAN specification	256
Sub-VLAN	Yes		
Sub-VLAN specification	1K		
VLAN mapping	Yes		
Selective QinQ	Yes		

Function and Feature		Description	CloudEngine S5731-H
		MUX VLAN	Yes
		Voice VLAN	Yes
		Guest VLAN	Yes
	GVRP	GARP	Yes
		GVRP	Yes
	VCMP	VCMP	Yes
	MAC	MAC address	288K
		Automatic learning of MAC addresses	Yes
		Automatic aging of MAC addresses	Yes
		Static, dynamic, and blackhole MAC address entries	Yes
		Interface-based MAC address learning limiting	Yes
		Sticky MAC	Yes
		MAC address flapping detection	Yes
		Configuring MAC address learning priorities for interfaces	Yes
		MAC address spoofing defense	Yes
		Port bridge	Yes
	ARP	Static ARP	Yes
		Dynamic ARP	Yes
		ARP entry	128K
		ARP aging detection	Yes
Intra-VLAN proxy ARP		Yes	
Inter-VLAN proxy ARP		Yes	
Routed proxy ARP		Yes	
Multi-egress-interface ARP	Yes		
Ethernet loop protection	MSTP	STP	Yes
		RSTP	Yes
		MSTP	Yes
		VBST	Yes
		BPDU protection	Yes
		Root protection	Yes
		Loop protection	Yes
		Defense against TC BPDUs attacks	Yes
	Loopback detection	Loop detection on an interface	Yes

Function and Feature		Description	CloudEngine S5731-H	
	SEP	SEP	Yes	
	Smart Link	Smart Link	Yes	
		Smart Link multi-instance	Yes	
		Monitor Link	Yes	
	RRPP	RRPP	Yes	
		Single RRPP ring	Yes	
		Tangent RRPP ring	Yes	
		Intersecting RRPP ring	Yes	
		Hybrid networking of RRPP rings and other ring networks	Yes	
	ERPS	G.8032 v1	Yes	
		G.8032 v2	Yes	
		ERPS semi-ring topology	Yes	
		ERPS closed-ring topology	Yes	
	IPv4/IPv6 forwarding	IPv4 and unicast routing	IPv4 static routing	Yes
			VRF	Yes
			DHCP client	Yes
DHCP server			Yes	
DHCP relay			Yes	
DHCP policy VLAN			Yes	
URPF check			Yes	
Routing policies			Yes	
IPv4 routes			512K	
RIPv1			Yes	
RIPv2			Yes	
OSPF			Yes	
BGP			Yes	
MBGP			Yes	
IS-IS		Yes		
Policy-based routing (PBR)		Yes		
Multicast routing features		IGMPv1/v2/v3	Yes	
		PIM-DM	Yes	
		PIM-SM	Yes	
		MSDP	Yes	
	IPv4 multicast routes	16K		

Function and Feature	Description	CloudEngine S5731-H	
		IPv6 multicast routes	16K
		Multicast routing policies	Yes
		RPF	Yes
	IPv6 features	IPv6 protocol stack	Yes
		ND	Yes
		ND entry	64K
		ND snooping	Yes
		DHCPv6 snooping	Yes
		RIPng	Yes
		DHCPv6 server	Yes
		DHCPv6 relay	Yes
		OSPFv3	Yes
		BGP4+	Yes
		IS-IS for IPv6	Yes
		IPv6 routes	64K
		VRRP6	Yes
		MLDv1/v2	Yes
		PIM-DM for IPv6	Yes
	PIM-SM for IPv6	Yes	
	IPv6 transition technology	IPv6 manual tunneling	Yes
Layer 2 multicast features	-	IGMPv1/v2/v3 snooping	Yes
		IGMP snooping proxy	Yes
		MLD snooping	Yes
		Multicast traffic suppression	Yes
		Inter-VLAN multicast replication	Yes
MPLS & VPN	MPLS basic functions	LDP protocol	Yes
		Double MPLS labels	Yes
		Mapping from 802.1p priorities to EXP priorities in MPLS packets	Yes
		Mapping from DSCP priorities to EXP priorities in MPLS packets	Yes
	MPLS TE	MPLS-TE tunnel establishment	Yes
		MPLS-TE tunnel specification	256
		MPLS-TE protection group	Yes
	VPN	MCE	Yes

Function and Feature		Description	CloudEngine S5731-H
		GRE tunneling	Yes
		GRE tunnel specification	512
		VLL	Yes
		PWE3	Yes
		VPLS	Yes
		MPLS L3VPN	Yes
		IPSec Efficient VPN	Yes
Device reliability	BFD	Single-hop BFD	Yes
		BFD for static routes	Yes
		BFD for OSPF	Yes
		BFD for IS-IS	Yes
		BFD for BGP	Yes
		BFD for PIM	Yes
		BFD for VRRP	Yes
	Stacking	Service interface-based stacking	Yes
		Maximum number of stacked devices	9
		Stack bandwidth (Bidirectional)	240Gbps(MAX)
VRRP	VRRP standard protocol	Yes	
Ethernet OAM	EFM (802.3ah)	Automatic discovery of links	Yes
		Link fault detection	Yes
		Link troubleshooting	Yes
		Remote loopback	Yes
	CFM (802.1ag)	Software-level CCM	Yes
		802.1ag MAC ping	Yes
		802.1ag MAC trace	Yes
	OAM association	Association between 802.1ag and 802.3ah	Yes
	Y.1731	Unidirectional delay and jitter measurement	Yes
		Bidirectional delay and jitter measurement	Yes
QoS features	Traffic classification	Traffic classification based on ACLs	Yes
		Matching the simple domains of packets	Yes
	Traffic behavior	Traffic filtering	Yes
		Traffic policing (CAR)	Yes
		Modifying the packet priorities	Yes
		Modifying the simple domains of packets	Yes

Function and Feature		Description	CloudEngine S5731-H
	Traffic shaping	Modifying the packet VLANs	Yes
		Traffic shaping on an egress interface	Yes
	Congestion avoidance	Traffic shaping on queues on an interface	Yes
		Weighted Random Early Detection (WRED) on queues	Yes
	Congestion management	Tail drop	Yes
		Priority Queuing (PQ)	Yes
		Weighted Deficit Round Robin (WDRR)	Yes
		PQ+WDRR	Yes
		Weighted Round Robin (WRR)	Yes
	ACL	Packet filtering at Layer 2 to Layer 4	PQ+WRR
Basic IPv4 ACL			Yes
Advanced IPv4 ACL			Yes
Basic IPv6 ACL			Yes
Advanced IPv6 ACL			Yes
Layer 2 ACL			Yes
User group ACL			Yes
User-defined ACL	Yes		
Configuration and maintenance	Login and configuration management	Command line interface (CLI)-based configuration	Yes
		Console terminal service	Yes
		Telnet terminal service	Yes
		SSH v1.5	Yes
		SSH v2.0	Yes
		SNMP-based NMS for unified configuration	Yes
		Web page-based configuration and management	Yes
		EasyDeploy (client)	Yes
		EasyDeploy (commander)	Yes
		SVF	Yes
		Cloud management	Yes
		OPS	Yes
	File system	Directory and file management	Yes
		File upload and download	Yes
	Monitoring and maintenance	Deception	Yes
ECA		Yes	

Function and Feature		Description	CloudEngine S5731-H
		eMDI	Yes
		Hardware monitoring	Yes
		Log information output	Yes
		Alarm information output	Yes
		Debugging information output	Yes
		Port mirroring	Yes
		Flow mirroring	Yes
		Remote mirroring	Yes
		Energy saving	Yes
		Version upgrade	Version upgrade
Version rollback	Yes		
Security	ARP security	ARP packet rate limiting	Yes
		ARP anti-spoofing	Yes
		Association between ARP and STP	Yes
		ARP gateway anti-collision	Yes
		Dynamic ARP Inspection (DAI)	Yes
		Static ARP Inspection (SAI)	Yes
		Egress ARP Inspection (EAI)	Yes
	IP security	ICMP attack defense	Yes
		IPSG for IPv4	Yes
		IPSG user capacity	3000
		IPSG for IPv6	Yes
		IPSGv6 user capacity	1500
	Local attack defense	CPU attack defense	Yes
	MFF	MFF	Yes
	MACSec	MACSec-256	Yes
	DHCP snooping	DHCP snooping	Yes
		Option 82 function	Yes
		Dynamic rate limiting for DHCP packets	Yes
	Attack defense	Defense against malformed packet attacks	Yes
		Defense against UDP flood attacks	Yes
		Defense against TCP SYN flood attacks	Yes
		Defense against ICMP flood attacks	Yes
		Defense against packet fragment attacks	Yes

Function and Feature		Description	CloudEngine S5731-H
		Local URPF	Yes
User access and authentication	AAA	Local authentication	Yes
		Local authorization	Yes
		RADIUS authentication	Yes
		RADIUS authorization	Yes
		RADIUS accounting	Yes
		HWTACACS authentication	Yes
		HWTACACS authorization	Yes
		HWTACACS accounting	Yes
	NAC	802.1X authentication	Yes
		MAC address authentication	Yes
		Portal authentication	Yes
		Hybrid authentication	Yes
	Policy association	Functioning as the control device	Yes
Network management	-	Ping	Yes
		Tracert	Yes
		NQA	Yes
		NTP	Yes
		iPCA	Yes
		Smart Application Control (SAC)	Yes
		NetStream	Yes
		SNMP v1	Yes
		SNMP v2c	Yes
		SNMP v3	Yes
		HTTP	Yes
		HTTPS	Yes
		RMON	Yes
		RMON2	Yes
		NETCONF/YANG	Yes
WLAN	-	AP management	Yes
		Number of managed APs	1,024
		Radio management	Yes
		WLAN service management	Yes
		WLAN QoS	Yes

Function and Feature		Description	CloudEngine S5731-H
		WLAN security	Yes
		WLAN user management	Yes
VXLAN	-	VXLAN Layer 2 gateway	Yes, require additional license
		VXLAN Layer 3 gateway	Yes, require additional license
		Centralized gateway	Yes, require additional license
		Distributed gateway	Yes, require additional license
		BGP-EVPN	Yes, require additional license
		BGP-EVPN neighbor capacity	256, require additional license
Interoperability	-	VLAN-based Spanning Tree (VBST)	Yes
		Link-type Negotiation Protocol (LNP)	Yes
		VLAN Central Management Protocol (VCMP)	Yes

NOTE

This content is applicable only to regions outside mainland China. Huawei reserves the right to interpret this content.

Hardware Specifications

The following table lists the hardware specifications of the CloudEngine S5731-H.

Item		CloudEngine S5731-H24HB4XZ	CloudEngine S5731-H48HB4XZ
Physical specifications	Dimensions (H x W x D, mm)	43.6 x 442 x 420	43.6 x 442 x 420
	Chassis height	1 U	1 U
	Chassis weight (including packaging)	8.4 kg	8.8 kg
Fixed port	GE port	20	40
	10GE SFP+ port	4 uplinks, 4 downlinks, can work at 1Gbps	4 uplinks, 4 downlinks, can work at 1Gbps
Extended slot		One extended slot, support 2 x 40GE QSFP+, 8 x 10GE Base-T and 8 x 10GE SFP+ or 2*25GE cards	
Management port	ETH port	Supported	Supported
	Console port (RJ45)	Supported	Supported
	USB port	USB 2.0	USB 2.0
CPU	Frequency	1.4 GHz	1.4 GHz
	Cores	4	4
Storage	Memory (RAM)	2 GB	2 GB
	Flash memory	1 GB	1 GB
Power supply system	Power supply type	<ul style="list-style-type: none"> 600 W PoE AC (pluggable) 	<ul style="list-style-type: none"> 600 W PoE AC (pluggable)

Item		CloudEngine S5731-H24HB4XZ	CloudEngine S5731-H48HB4XZ
		<ul style="list-style-type: none"> 1000 W PoE AC (pluggable) 1000 W PoE DC (pluggable) 	<ul style="list-style-type: none"> 1000 W PoE AC (pluggable) 1000 W PoE DC (pluggable)
	Rated voltage range	<ul style="list-style-type: none"> AC input (600 /1000 W PoE AC): 100 V AC to 240 V AC, 50/60 Hz AC input (600 /1000 W PoE AC): 240 V DC, DC input (1000 W PoE DC): -48 VDC to -60 V DC 	<ul style="list-style-type: none"> AC input (600 /1000W PoE AC): 100 V AC to 240 V AC, 50/60 Hz AC input (600 /1000 W PoE AC): 240 V DC, DC input (1000 W PoE DC): -48 VDC to -60 V DC
	Maximum voltage range	<ul style="list-style-type: none"> AC input (600W /1000 W PoE AC): 90 V AC to 290 V AC, 45 Hz to 65 Hz High-voltage DC input (600W /1000 W PoE AC): 190 V DC to 290 V DC (meeting 240 V high-voltage DC certification) DC input (1000 W PoE DC): -38.4 V DC to -72V DC 	<ul style="list-style-type: none"> AC input (600W /1000 W PoE AC): 90 V AC to 290 V AC, 45 Hz to 65 Hz High-voltage DC input (600W /1000 W PoE AC): 190 V DC to 290 V DC (meeting 240 V high-voltage DC certification) DC input (1000 W PoE DC): -38.4 V DC to -72V DC
	Maximum power consumption	<ul style="list-style-type: none"> 127 W (without PD) 1927 W (with PD, PD power consumption of 1768W) 	<ul style="list-style-type: none"> 151 W (without PD) 1927 W (with PD, PD power consumption of 1745W)
	Minimum power consumption	66W	66W
	Typical Power Consumption	87W	118W
Heat dissipation system	Heat dissipation mode	Air cooling for heat dissipation, intelligent fan speed adjustment	Air cooling for heat dissipation, intelligent fan speed adjustment
	Number of fan modules	2	2
	Airflow	Air intake from left, front, and right and air exhaust from rear	Air intake from left, front, and right and air exhaust from rear
	Maximum heat dissipation of the device (BTU/hour)	POE: 6575.12 non PoE: 433.34	POE: 6575.12 non PoE: 515.23
Environment parameters	Long-term operating temperature	<ul style="list-style-type: none"> 0-1800 m: -5°C to 45°C 1800-5000 m: The operating temperature decreases 1°C every time the altitude increases 220 m. 	<ul style="list-style-type: none"> 0-1800 m: -5°C to 45°C 1800-5000 m: The operating temperature decreases 1°C every time the altitude increases 220 m.
	Storage temperature	-40°C to +70°C	-40°C to +70°C
	Relative humidity	5%–95% (non-condensing)	5%–95% (non-condensing)
	Operating altitude	0–5000 m	0–5000 m
	Noise under normal temperature (sound power)	<ul style="list-style-type: none"> Dual-AC 600 W, 70% load: 57.77 dBA Dual-AC 1000 W, 70% load: 63.78 dBA 	<ul style="list-style-type: none"> Dual-AC 600 W, 70% load: 57.77 dBA Dual-AC 1000 W, 70% load: 63.78 dBA

Item		CloudEngine S5731-H24HB4XZ	CloudEngine S5731-H48HB4XZ
		<ul style="list-style-type: none"> Dual-DC 1000 W, 70% load: 62.38 dBA Dual-AC 600 W, 100% load: 63.78 dBA Dual-AC 1000 W, 100% load: 68.07 dBA Dual-DC 1000 W, 100% load: 66.26 dBA 	Dual-DC 1000 W, 70% load: 62.38 dBA Dual-AC 600 W, 100% load: 63.78 dBA Dual-AC 1000 W, 100% load: 68.07 dBA Dual-DC 1000 W, 100% load: 66.26 dBA
	Noise under high temperature (sound power)	Dual-AC 600 W, 100% load: 70.63 dBA Dual-AC 1000 W, 100% load: 81.05 dBA Dual-DC 1000 W, 100% load: 73.79 dBA	Dual-AC 600 W, 100% load: 70.63 dBA Dual-AC 1000 W, 100% load: 81.05 dBA Dual-DC 1000 W, 100% load: 73.79 dBA
	Surge protection specification (power port)	<ul style="list-style-type: none"> AC power port: ± 6 kV in differential mode, ± 6 kV in common mode DC power port: ± 2 kV in differential mode, ± 4 kV in common mode 	<ul style="list-style-type: none"> AC power port: ± 6 kV in differential mode, ± 6 kV in common mode DC power port: ± 2 kV in differential mode, ± 4 kV in common mode
Reliability	MTBF (year) ²	53.82	53.82
	MTTR (hour)	2	2
	Availability	> 0.99999	> 0.99999
Certification		<ul style="list-style-type: none"> EMC certification Safety certification Manufacturing certification For details about certifications, see the section Safety and Regulatory Compliance.	<ul style="list-style-type: none"> EMC certification Safety certification Manufacturing certification For details about certifications, see the section Safety and Regulatory Compliance.

NOTE

1: The power consumption under different load conditions is calculated according to the ATIS standard. Additionally, the EEE function is enabled and there is no PoE power output.

2: The reliability parameter values are calculated based on the typical configuration of the device. The parameter values vary according to the modules configured by the customer.

Networking and Applications

Large-Scale Enterprise Campus Network

CloudEngine S12700E or S7700 switches are used as the core of the campus network. Independent firewalls are used to implement platform security in the DMZ. Central switches and remote units as access switches to provide wired or wireless access services for campus terminals. These switches can be widely used in government and enterprise offices, commercial buildings, energy and electricity, manufacturing and other industries.

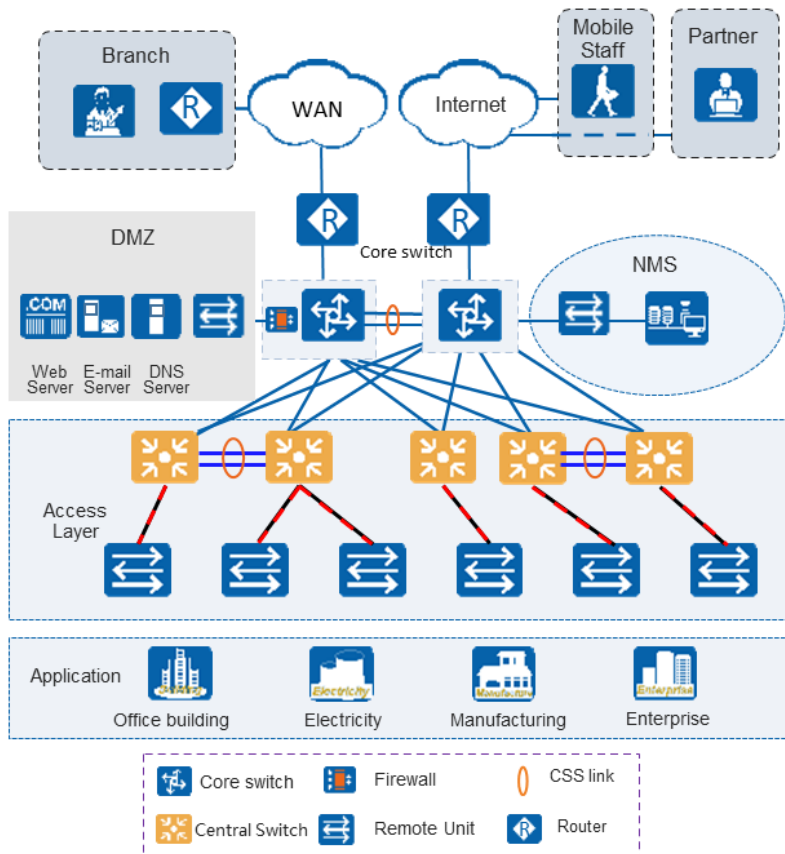

Small- or Medium-scale Enterprise Campus Network

CloudEngine S5731-H series switches are used as the core of a small- and medium-sized campus network. Independent firewalls are used to implement platform security in the DMZ. Central switches use remote modules to flexibly expand ports to provide access services for end users.

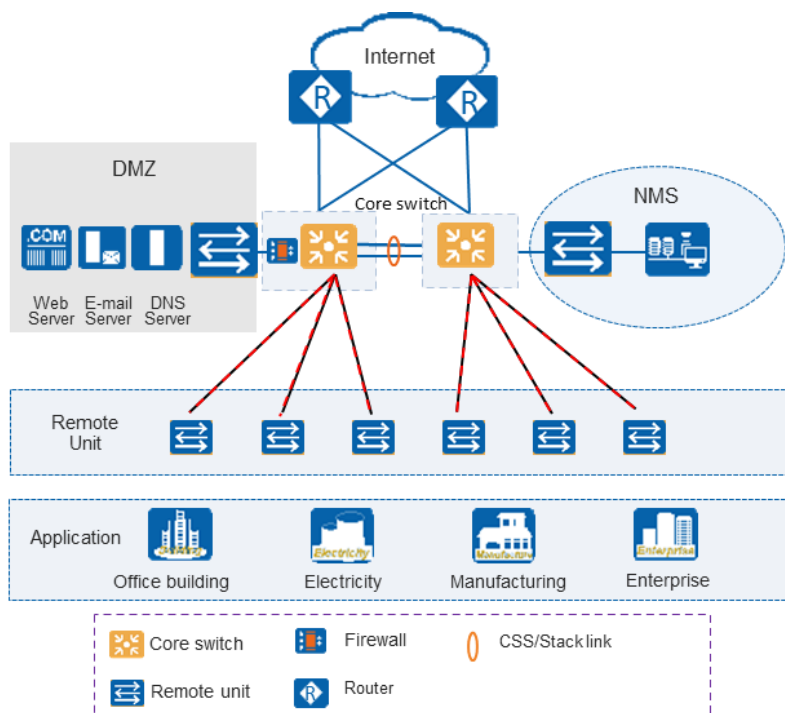

Small-scale Enterprise Campus Network

With powerful aggregation and routing capabilities of CloudEngine S5731-H series switches make them suitable for use as core switches in a small-scale enterprise network. Two or more S5731-H switches use iStack technology to ensure high reliability. They provide a variety of access control policies to achieve centralized management and simplify configuration.

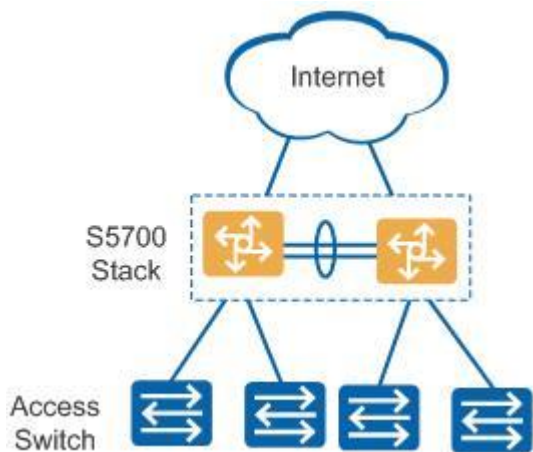

Application on a MAN

CloudEngine S5731-H series switches can be deployed at the access layer of a MAN (Metropolitan Area Network) to build a high-performance, multi-service, and highly reliable ISP MAN network.

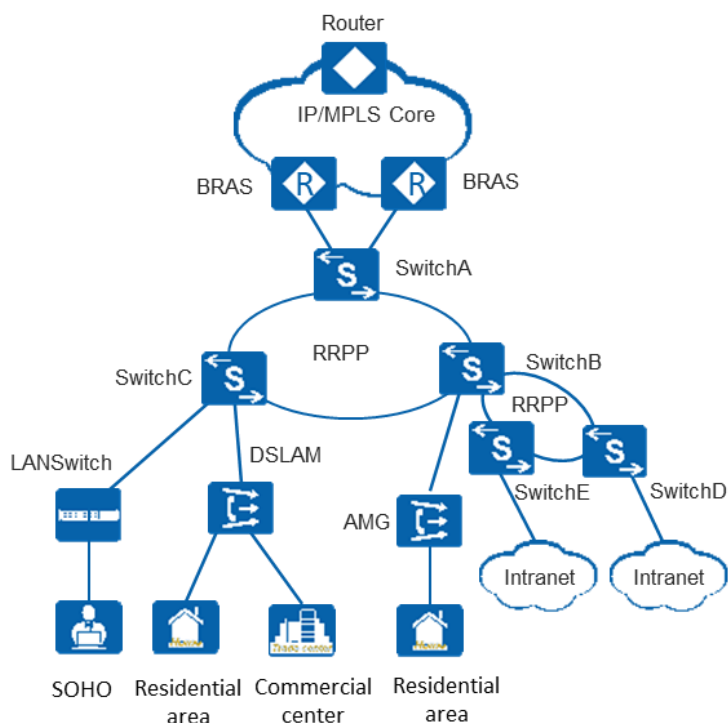

Application in Public Cloud

CloudCampus Solution is a network solution suite based on Huawei public cloud. CloudEngine S5731-H series switches can be located at the access layer.

The switches are plug-and-play. They go online automatically after being powered on and connected with network cables, without the need for complex configurations. The switches can connect to the management and control system (CloudCampus@AC-Campus for switches running V200R019C00 and earlier versions; iMaster NCE-Campus for switches running V200R019C10 and later versions), and use bidirectional certificate authentication to ensure management channel security. The switches provide the NETCONF and YANG interfaces, through which the management and control system delivers configurations to them. In addition, remote maintenance and fault diagnosis can be performed on the management and control system.

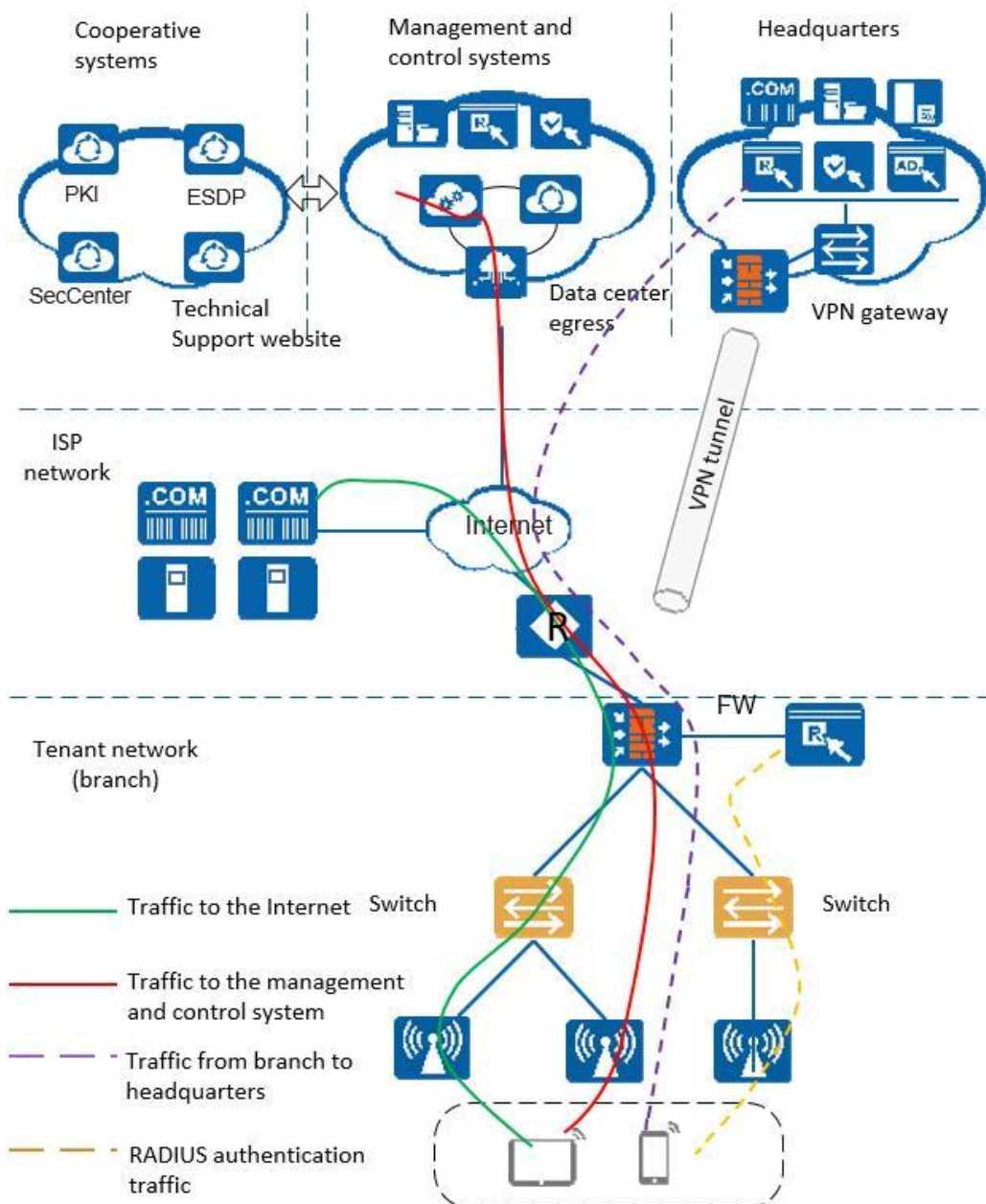

Safety and Regulatory Compliance

The following table lists the safety and regulatory compliance of the CloudEngine S5731-H.

Safety and regulatory compliance of the CloudEngine S5731-H series

Certification Category	Description
Safety	<ul style="list-style-type: none"> • IEC 60950-1 • EN 60950-1/A11/A12 • UL 60950-1 • CSA C22.2 No 60950-1 • AS/NZS 60950.1 • CNS 14336-1 • IEC60825-1 • IEC60825-2

Certification Category	Description
	<ul style="list-style-type: none"> • EN60825-1 • EN60825-2
Electromagnetic Compatibility (EMC)	<ul style="list-style-type: none"> • CISPR22 Class A • CISPR24 • EN55022 Class A • EN55024 • ETSI EN 300 386 Class A • CFR 47 FCC Part 15 Class A • ICES 003 Class A • AS/NZS CISPR22 Class A • VCCI Class A • IEC61000-4-2 • ITU-T K 20 • ITU-T K 21 • ITU-T K 44 • CNS13438
Environment	<ul style="list-style-type: none"> • RoHS • REACH • WEEE

NOTE

- EMC: electromagnetic compatibility
- CISPR: International Special Committee on Radio Interference
- EN: European Standard
- ETSI: European Telecommunications Standards Institute
- CFR: Code of Federal Regulations
- FCC: Federal Communication Commission
- IEC: International Electrotechnical Commission
- AS/NZS: Australian/New Zealand Standard
- VCCI: Voluntary Control Council for Interference
- UL: Underwriters Laboratories
- CSA: Canadian Standards Association
- IEEE: Institute of Electrical and Electronics Engineers
- RoHS: restriction of the use of certain hazardous substances
- REACH: Registration Evaluation Authorization and Restriction of Chemicals
- WEEE: Waste Electrical and Electronic Equipment

MIB and Standards Compliance

Supported MIBs

The following table lists the MIBs supported by the CloudEngine S5731-H.

MIBs supported by the CloudEngine S5731-H series

Category	MIB
Public MIB	<ul style="list-style-type: none"> • BRIDGE-MIB

Category	MIB
	<ul style="list-style-type: none"> • DISMAN-NSLOOKUP-MIB • DISMAN-PING-MIB • DISMAN-TRACEROUTE-MIB • ENTITY-MIB • EtherLike-MIB • IF-MIB • IP-FORWARD-MIB • IPv6-MIB • LAG-MIB • LLDP-EXT-DOT1-MIB • LLDP-EXT-DOT3-MIB • LLDP-MIB • MPLS-FTN-STD-MIB • MPLS-L3VPN-STD-MIB • MPLS-LDP-GENERIC-STD-MIB • MPLS-LDP-STD-MIB • MPLS-LSR-STD-MIB • MPLS-TE-STD-MIB • NOTIFICATION-LOG-MIB • NQA-MIB • OSPF-TRAP-MIB • P-BRIDGE-MIB • Q-BRIDGE-MIB • RFC1213-MIB • RIPv2-MIB • RMON2-MIB • RMON-MIB • SAVI-MIB • SNMP-FRAMEWORK-MIB • SNMP-MPD-MIB • SNMP-NOTIFICATION-MIB • SNMP-TARGET-MIB • SNMP-USER-BASED-SM-MIB • SNMPv2-MIB • TCP-MIB • UDP-MIB
Huawei-proprietary MIB	<ul style="list-style-type: none"> • HUAWEI-AAA-MIB • HUAWEI-ACL-MIB • HUAWEI-ALARM-MIB • HUAWEI-ALARM-RELIABILITY-MIB • HUAWEI-BASE-TRAP-MIB • HUAWEI-BRAS-RADIUS-MIB • HUAWEI-BRAS-SRVCFG-EAP-MIB • HUAWEI-BRAS-SRVCFG-STATICUSER-MIB

Category	MIB
	<ul style="list-style-type: none"> • HUAWEI-CBQOS-MIB • HUAWEI-CDP-COMPLIANCE-MIB • HUAWEI-CONFIG-MAN-MIB • HUAWEI-CPU-MIB • HUAWEI-DAD-TRAP-MIB • HUAWEI-DC-MIB • HUAWEI-DATASYNC-MIB • HUAWEI-DEVICE-MIB • HUAWEI-DHCPR-MIB • HUAWEI-DHCPS-MIB • HUAWEI-DHCP-SNOOPING-MIB • HUAWEI-DIE-MIB • HUAWEI-DNS-MIB • HUAWEI-DLDP-MIB • HUAWEI-ELMI-MIB • HUAWEI-ERPS-MIB • HUAWEI-ERRORDOWN-MIB • HUAWEI-ENERGYMNGT-MIB • HUAWEI-EASY-OPERATION-MIB • HUAWEI-ENTITY-EXTENT-MIB • HUAWEI-ENTITY-TRAP-MIB • HUAWEI-ETHARP-MIB • HUAWEI-ETHOAM-MIB • HUAWEI-FLASH-MAN-MIB • HUAWEI-FWD-RES-TRAP-MIB • HUAWEI-GARP-APP-MIB • HUAWEI-GTSM-MIB • HUAWEI-HGMP-MIB • HUAWEI-HWTACACS-MIB • HUAWEI-IF-EXT-MIB • HUAWEI-INFOCENTER-MIB • HUAWEI-IPPOOL-MIB • HUAWEI-IPV6-MIB • HUAWEI-ISOLATE-MIB • HUAWEI-L2IF-MIB • HUAWEI-L2MAM-MIB • HUAWEI-L2VLAN-MIB • HUAWEI_LDT-MIB • HUAWEI-LLDP-MIB • HUAWEI-MAC-AUTHEN-MIB • HUAWEI-MEMORY-MIB • HUAWEI-MFF-MIB • HUAWEI-MFLP-MIB • HUAWEI-MSTP-MIB • HUAWEI-BGP-VPN-MIB

Category	MIB
	<ul style="list-style-type: none"> • HUAWEI-CCC-MIB • HUAWEI-MULTICAST-MIB • HUAWEI-NAP-MIB • HUAWEI-NTPV3-MIB • HUAWEI-PERFORMANCE-MIB • HUAWEI-PORT-MIB • HUAWEI-PORTAL-MIB • HUAWEI-QINQ-MIB • HUAWEI-RIPv2-EXT-MIB • HUAWEI-RM-EXT-MIB • HUAWEI-RRPP-MIB • HUAWEI-SECURITY-MIB • HUAWEI-SEP-MIB • HUAWEI-SNMP-EXT-MIB • HUAWEI-SSH-MIB • HUAWEI-STACK-MIB • HUAWEI-SWITCH-L2MAM-EXT-MIB • HUAWEI-SWITCH-SRV-TRAP-MIB • HUAWEI-SYS-MAN-MIB • HUAWEI-TCP-MIB • HUAWEI-TFTPC-MIB • HUAWEI-TRNG-MIB • HUAWEI-XQOS-MIB

Standard Compliance

The following table lists the standards that the CloudEngine S5731-H complies with.

[Standard compliance list of the CloudEngine S5731-H series](#)

Standard Organization	Standard or Protocol
IETF	<ul style="list-style-type: none"> • RFC 768 User Datagram Protocol (UDP) • RFC 792 Internet Control Message Protocol (ICMP) • RFC 793 Transmission Control Protocol (TCP) • RFC 826 Ethernet Address Resolution Protocol (ARP) • RFC 854 Telnet Protocol Specification • RFC 951 Bootstrap Protocol (BOOTP) • RFC 959 File Transfer Protocol (FTP) • RFC 1058 Routing Information Protocol (RIP) • RFC 1112 Host extensions for IP multicasting • RFC 1157 A Simple Network Management Protocol (SNMP) • RFC 1256 ICMP Router Discovery • RFC 1305 Network Time Protocol Version 3 (NTP) • RFC 1349 Internet Protocol (IP) • RFC 1493 Definitions of Managed Objects for Bridges • RFC 1542 Clarifications and Extensions for the Bootstrap Protocol

Standard Organization	Standard or Protocol
	<ul style="list-style-type: none"> • RFC 1643 Ethernet Interface MIB • RFC 1757 Remote Network Monitoring (RMON) • RFC 1901 Introduction to Community-based SNMPv2 • RFC 1902-1907 SNMP v2 • RFC 1981 Path MTU Discovery for IP version 6 • RFC 2131 Dynamic Host Configuration Protocol (DHCP) • RFC 2328 OSPF Version 2 • RFC 2453 RIP Version 2 • RFC 2460 Internet Protocol, Version 6 Specification (IPv6) • RFC 2461 Neighbor Discovery for IP Version 6 (IPv6) • RFC 2462 IPv6 Stateless Address Auto configuration • RFC 2463 Internet Control Message Protocol for IPv6 (ICMPv6) • RFC 2474 Differentiated Services Field (DS Field) • RFC 2740 OSPF for IPv6 (OSPFv3) • RFC 2863 The Interfaces Group MIB • RFC 2597 Assured Forwarding PHB Group • RFC 2598 An Expedited Forwarding PHB • RFC 2571 SNMP Management Frameworks • RFC 2865 Remote Authentication Dial In User Service (RADIUS) • RFC 3046 DHCP Option82 • RFC 3376 Internet Group Management Protocol, Version 3 (IGMPv3) • RFC 3513 IP Version 6 Addressing Architecture • RFC 3579 RADIUS Support For EAP • RFC 4271 A Border Gateway Protocol 4 (BGP-4) • RFC 4760 Multiprotocol Extensions for BGP-4 • draft-grant-tacacs-02 TACACS+ • RFC 6241 Network Configuration Protocol (NETCONF) • RFC 6020 YANG - A Data Modeling Language for the Network Configuration Protocol (NETCONF)
IEEE	<ul style="list-style-type: none"> • IEEE 802.1D Media Access Control (MAC) Bridges • IEEE 802.1p Traffic Class Expediting and Dynamic Multicast Filtering • IEEE 802.1Q Virtual Bridged Local Area Networks • IEEE 802.1ad Provider Bridges • IEEE 802.2 Logical Link Control • IEEE Std 802.3 CSMA/CD • IEEE Std 802.3ab 1000BASE-T specification • IEEE Std 802.3ad Aggregation of Multiple Link Segments • IEEE Std 802.3ae 10GE WEN/LAN Standard • IEEE Std 802.3x Full Duplex and flow control • IEEE Std 802.3z Gigabit Ethernet Standard • IEEE802.1ax/IEEE802.3ad Link Aggregation • IEEE 802.3ah Ethernet in the First Mile. • IEEE 802.1ag Connectivity Fault Management • IEEE 802.1ab Link Layer Discovery Protocol

Standard Organization	Standard or Protocol
	<ul style="list-style-type: none"> • IEEE 802.1D Spanning Tree Protocol • IEEE 802.1w Rapid Spanning Tree Protocol • IEEE 802.1s Multiple Spanning Tree Protocol • IEEE 802.1x Port based network access control protocol • IEEE 802.3af DTE Power via MIDI • IEEE 802.3at DTE Power via the MDI Enhancements • IEEE 802.3az Energy Efficient Ethernet
ITU	<ul style="list-style-type: none"> • ITU SG13 Y.17ethoam • ITU SG13 QoS control Ethernet-Based IP Access • ITU-T Y.1731 ETH OAM performance monitor
ISO	<ul style="list-style-type: none"> • ISO 10589 IS-IS Routing Protocol
MEF	<ul style="list-style-type: none"> • MEF 2 Requirements and Framework for Ethernet Service Protection • MEF 9 Abstract Test Suite for Ethernet Services at the UNI • MEF 10.2 Ethernet Services Attributes Phase 2 • MEF 11 UNI Requirements and Framework • MEF 13 UNI Type 1 Implementation Agreement • MEF 15 Requirements for Management of Metro Ethernet Phase 1 Network Elements • MEF 17 Service OAM Framework and Requirements • MEF 20 UNI Type 2 Implementation Agreement • MEF 23 Class of Service Phase 1 Implementation Agreement • Xmodem XMODEM/YMODEM Protocol Reference

Ordering Information

Model	Product Description
CloudEngine S5731-H24HB4XZ	CloudEngine S5731-H24HB4XZ(20*GE SFP ports, 4*10GE SFP+ ports, 4*10GE SFP+ ports, 1*expansion slot, PoE++, without power module)
CloudEngine S5731-H48HB4XZ	CloudEngine S5731-H48HB4XZ(44*GE SFP ports, 4*10GE SFP+ ports, 4*10GE SFP+ ports, 1*expansion slot, PoE++, without power module)
S7Q02001	2-port 40GE QSFP+ interface card
ES5D21X08T00	8-port 10GBASE-T interface card
S7X08000	2-port 25GE SFP28 or 8-port 10GE SFP+ interface card
PAC600S56-CB	600 W AC Power Module
PAC1000S56-DB	1000 W AC PoE power module
PAC1000S56-CB	1000 W AC PoE power module
PDC1000S56-CB	1000 W DC PoE power module
FAN-023A-B	Fan module, Air flows in from the front side and exhausts from the rear panel.
L-512AP-S57	S57 Series, Wireless Access Controller AP Resource License-512AP
L-64AP-S57	S57 Series, Wireless Access Controller AP Resource License-64AP

Model	Product Description
L-32AP-S57	S57 Series, Wireless Access Controller AP Resource License-32AP
L-1AP-S57	S57 Series, Wireless Access Controller AP Resource License-1AP
L-VxLAN-S57	S57 Series, VxLAN License, Per Device
N1-S57H-M-Lic	S57XX-H Series Basic SW,Per Device
N1-S57H-M-SnS1Y	S57XX-H Series Basic SW,SnS,Per Device,1Year
N1-S57H-F-Lic	N1-CloudCampus,Foundation,S57XX-H Series,Per Device
N1-S57H-F-SnS1Y	N1-CloudCampus,Foundation,S57XX-H Series,SnS,Per Device,1Year
N1-S57H-A-Lic	N1-CloudCampus,Advanced,S57XX-H Series,Per Device
N1-S57H-A-SnS1Y	N1-CloudCampus,Advanced,S57XX-H Series,SnS,Per Device,1Year
N1-S57H-FToA-Lic	N1-Upgrade-Foundation to Advanced,S57XX-H,Per Device
N1-S57H-FToA-SnS1Y	N1-Upgrade-Foundation to Advanced,S57XX-H,SnS,Per Device,1Year

More Information

For more information about Huawei Campus Switches, visit <http://e.huawei.com> or contact us in the following ways:

- Global service hotline: <http://e.huawei.com/en/service-hotline>
- Logging in to the Huawei Enterprise technical support website: <http://support.huawei.com/enterprise/>
- Sending an email to the customer service mailbox: support_e@huawei.com

Copyright © Huawei Technologies Co., Ltd. 2022. All rights reserved.

No part of this document may be reproduced or transmitted in any form or by any means without prior written consent of Huawei Technologies Co., Ltd.

Trademarks and Permissions

 HUAWEI and other Huawei trademarks are trademarks of Huawei Technologies Co., Ltd.

All other trademarks and trade names mentioned in this document are the property of their respective holders.

Notice

The purchased products, services and features are stipulated by the contract made between Huawei and the customer. All or part of the products, services and features described in this document may not be within the purchase scope or the usage scope. Unless otherwise specified in the contract, all statements, information, and recommendations in this document are provided "AS IS" without warranties, guarantees or representations of any kind, either express or implied.

The information in this document is subject to change without notice. Every effort has been made in the preparation of this document to ensure accuracy of the contents, but all statements, information, and recommendations in this document do not constitute a warranty of any kind, express or implied.

Huawei Technologies Co., Ltd.

Address:Huawei Industrial Base Bantian,
Longgang Shenzhen 518129 People's
Republic of China

Website:e.huawei.com